

## M7009 SERIES

*DC/DC POWER SUPPLY*



### PRODUCT HIGHLIGHTS

- MINIATURE
- HIGH DENSITY
- SINGLE OUTPUT
- DC/DC POWER SUPPLY
- UP TO 75 W



**Cham, Switzerland**  
[www.enercon-europe.com](http://www.enercon-europe.com)  
[enercon@enercon-europe.com](mailto:enercon@enercon-europe.com)  
+41 41 740 4554

Global Headquarters

**Netanya, Israel**  
[www.enercon.co.il](http://www.enercon.co.il)  
[sales@enercon.co.il](mailto:sales@enercon.co.il)  
+972-73-246 9200



**Gurgaon, India**  
[www.mpsindia.in](http://www.mpsindia.in)  
[sales@mpsindia.in](mailto:sales@mpsindia.in)  
+91-124-651 0010

**Applications**

Military (Airborne, ground-fix, shipboard), Ruggedized, Telecom, Industrial Power Supply

**Special Features**

- Miniature size
- High efficiency
- Input / Output isolation
- Fixed switching freq.
- EMI filters included
- Remote inhibit (On/Off)
- Non-latching protections:
  - Input under/over voltage
  - Overload/Short-circuit
  - Over temperature

**Electrical Specifications**

**DC Input**

Normal steady-state voltage range: 18 to 36 V<sub>DC</sub>

**Abnormal transient protection<sup>†</sup>**

MIL-STD-1275A (100 V for 50 ms)  
MIL-STD-704A (80 V for 0.1 s)

**Output voltage regulation**

Less than ±1% (low to high input voltage, no load to full load, -55 °C to +85 °C at baseplate).

**DC Output**

Voltage range: 3.3 to 56 V  
Current range: 0 to 10 A  
Power range: 0 to 75 W

**Efficiency**

80% typical (28V variant, at nominal input voltage, full load, room temperature)

**Ripple and Noise**

100-150 mV<sub>p-p</sub>, typical (max. 1%) without external capacitance.

**Isolation**

Input to Output: 200 V<sub>DC</sub>  
Input to Case: 200 V<sub>DC</sub>  
Output to Case: 100 V<sub>DC</sub>

**EMC**

Meets\* MIL-STD-461F  
CE102, CS101, CS114, CS115, CS116, RE102, RS103.  
Designed to meet\* MIL-STD-461F  
CE101, RE101, RS101

**Turn-on Transient**

No overshoot.

<sup>†</sup> Converter will not be damaged, but may shutdown during the transient, and restart once input voltage is back within range.

\* Compliance achieved with 5µH LISN, shielded harness and static resistive load.

**Protections** \*\*

**Input**

- **Under-Voltage Lockout**  
Converter shuts if input voltage is below  $16 \pm 1V$ .
- **Over-Voltage Lockout**  
Converter shuts down if input voltage is above  $51 \pm 2V$ .

**Output**

- **Active Over-Voltage Protection**  
Passive transorb selected at  $110\% \pm 5\%$  at output.
- **Passive Over-Voltage Protection**  
Transorb at output selected  $20\% \pm 5\%$  above nominal voltage.
- **Overload / Short-Circuit Protection**  
Output voltage turns off and on periodically with low duty-cycle (hiccup) to protect system conductors and converter from short circuit.

**General**

- **Over Temperature Protection**  
Shutdown if baseplate temperature exceeds  $+105\text{ }^\circ\text{C} \pm 5\text{ }^\circ\text{C}$ .  
Automatic recovery upon cooldown to below  $+95\text{ }^\circ\text{C} \pm 5\text{ }^\circ\text{C}$ .

**Environmental Conditions**

Designed to meet MIL-STD-810G

**Temperature**

Methods 501.5 & 502.5  
Operating:  $-55\text{ }^\circ\text{C}$  to  $+85\text{ }^\circ\text{C}$  (at baseplate)  
Storage:  $-55\text{ }^\circ\text{C}$  to  $+125\text{ }^\circ\text{C}$  (ambient)

**Altitude**

Method 500.5  
Procedures I – up to 70,000 ft. (non-operational)  
Procedure II – up to 70,000 ft. (operational)

**Humidity**

Method 507.5  
Up to 95% RH

**Vibration**

Method 514.6  
  
Category 7: Aircraft – Jet, IAW figure C-6, 13.7grms, 1 hour per axis.  
  
Category 24: Minimum integrity, IAW figure E-3, 7.7 grms, 1 hour per axis.

**Shock**

Method 516.6  
Operational shock: 30 g, 11 ms, half-sine  
Crash safety: 100 g, 6 ms, half-sine

**Salt Fog**

Method 509.5

**Reliability**

150,000 hours, calculated per MIL-STD-217F Notice 2 at  $+85\text{ }^\circ\text{C}$  baseplate, Ground Fix environment.

**Environmental Stress Screening (ESS)**

Including random vibration and thermal cycles is also available. Please consult factory for details.

---

\*\* Thresholds and protections can be modified / removed – please consult factory.

Typical Efficiency/Loss Curves

M7009-101 (12 V<sub>DC</sub> output)

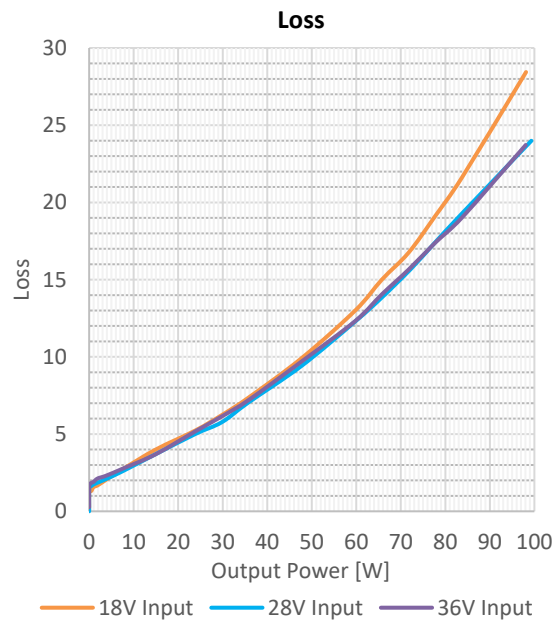
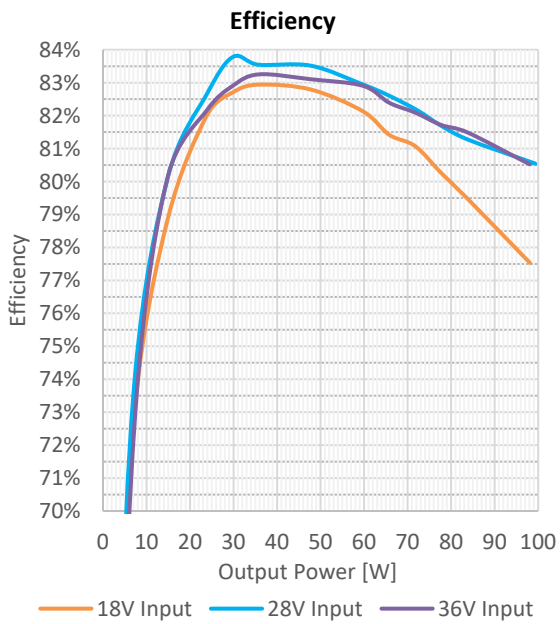

M7009-104 (28 V<sub>DC</sub> output)

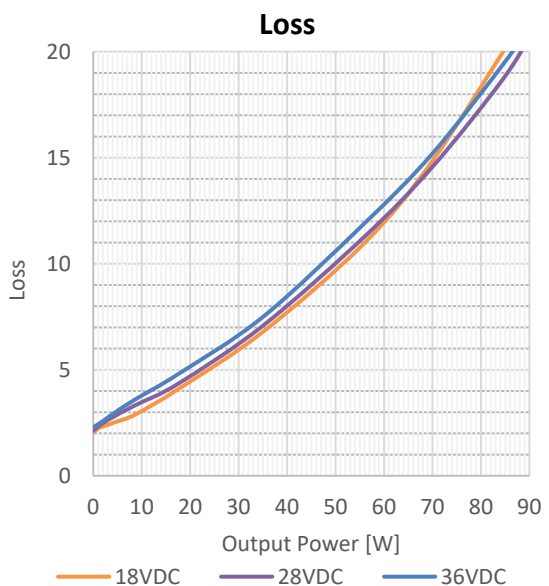
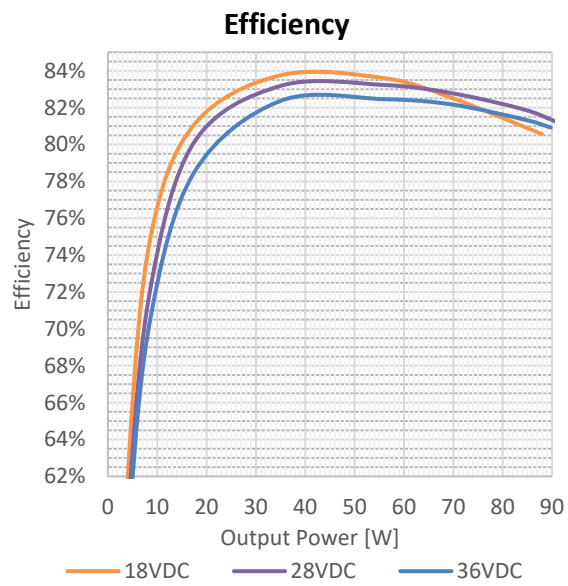

**Typical MIL-STD-461F Conducted Emissions Plots**

The following measurements were performed with 5  $\mu$ H LISNs

**M7009-101 (12 V<sub>DC</sub> output)**

Test conditions:

Input	Voltage: 28.074 V <sub>DC</sub>	Current: 6.048 A	Power: 72.68 W
Output	Voltage: 12.018 V <sub>DC</sub>		

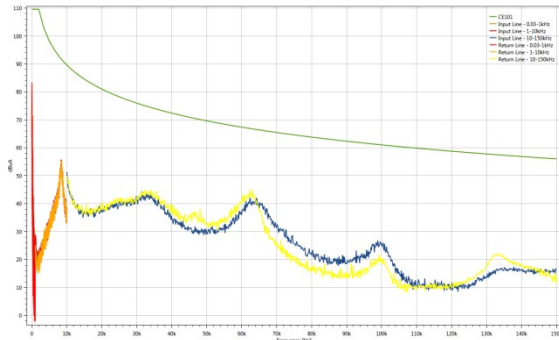

CE101 (30 Hz to 150 kHz)

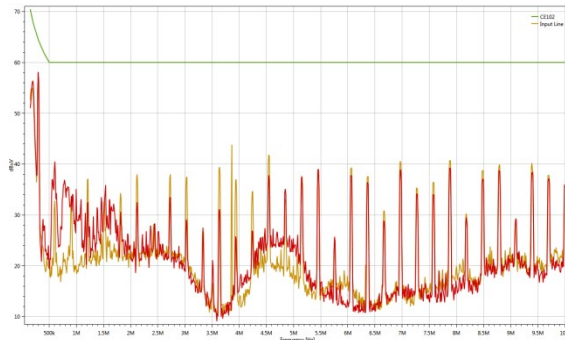

CE102 (150 kHz to 10 MHz)

**M7009-104 (28 V<sub>DC</sub> output)**

Test conditions:

Input	Voltage: 28.01 V <sub>DC</sub>	Current: 2.8524 A	Power: 79.9 W
Output	Voltage: 28.015 V <sub>DC</sub>		

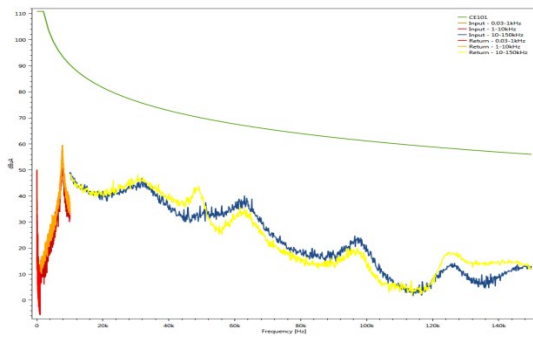

CE101 (30 Hz to 150 kHz)

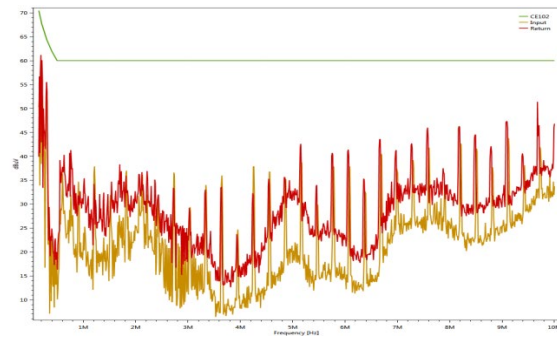

CE102 (150 kHz to 10 MHz)

**Functions and Signals**

**INHIBIT** (pin 8)

Description: The **INHIBIT** signal is used to turn the power supply ON and OFF.

Operation: Applying “1” or leaving open will turn the power supply ON. For constant operation, leave this pin unconnected.

Applying “0” or shorting this pin to its return line will turn the power supply OFF. (Optional to change the logic of this signal. Please consult with factory.)

Signal Type: 5V TTL or dry contact (open/short).

Return line: This signal is referenced to **INHIBIT RTN** pin.

Optional to change the logic of these signals. Please consult with the factory.

**SENSE** (pin 2) & **SENSE RTN** (pin 3)

Description: The **SENSE** is used to compensate for voltage drop across the output wires by sensing the voltage at the load and correcting the increasing the output voltage accordingly, to provide the desired voltage at the load's terminals.

Operation: Connect the **SENSE** pin to the positive load terminal, and the **SENSE RTN** pin to the negative (return) load terminal.

The sense compensation is typically limited to 5% or 0.5V – the lesser of the two.

If not used, connect **SENSE** directly to **OUTPUT** pins, and the **SENSE RTN** pin directly to the **OUTPUT RTN** pins.

**IMPORTANT: to avoid damage to the converter and/or the load - DO NOT LEAVE THE SENSE/SENSE RTN PINS UNCONNECTED.**

**Pin Assignment**

Connector: M24308/24-38F or eq.

Mates with: M24308/2-2F or eq.

Pin No.	Function		
1	OUTPUT	+	●
2	SENSE	+	⊗
3	SENSE RTN	-	⊗
4	OUTPUT RTN	-	●
5	OUTPUT RTN	-	●
6	INPUT RTN	-	●
7	INPUT	+	●
8	INHIBIT	+	●

Pin No.	Function		
9	OUTPUT	+	●
10	OUTPUT	+	●
11	OUTPUT	+	●
12	OUTPUT RTN	-	●
13	OUTPUT RTN	-	●
14	INPUT RTN	-	●
15	INPUT	+	●

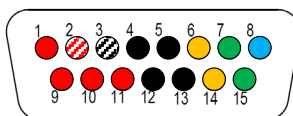

**Outline Drawing**

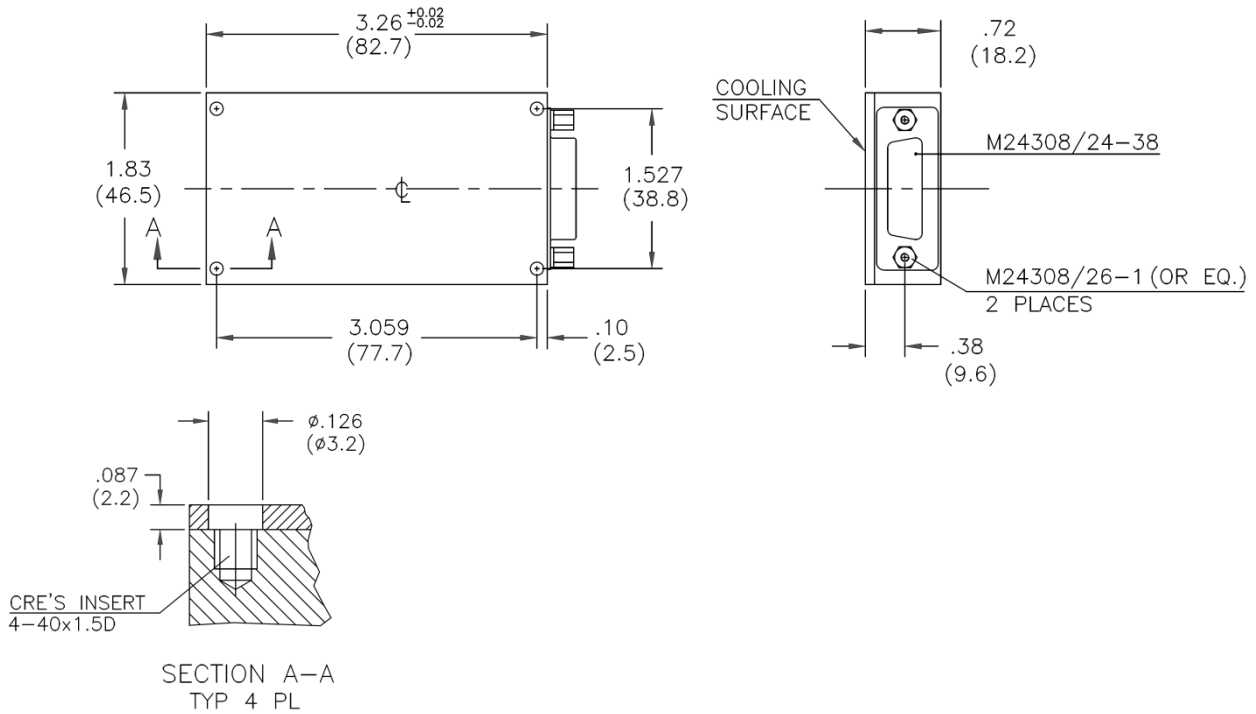

**Notes**

1. Dimensions are in inches  
[mm]
2. Tolerance is:  
.XX  $\pm$  0.01 in  
.XXX  $\pm$  0.005 in

**Standard Configurations**

This PN can be configured to any output voltage within its possible range (see 'DC Output – Voltage range' in 'Electrical Specifications' table).

Part Number	Output Voltage	Max Output Current
M7009-100	5 V <sub>DC</sub>	10 A
M7009-101	12 V <sub>DC</sub>	6 A
M7009-102	15 V <sub>DC</sub>	5 A
M7009-103	24 V <sub>DC</sub>	3 A
M7009-104	28 V <sub>DC</sub>	2.5 A
M7009-105	48 V <sub>DC</sub>	1.5 A

***Note: Specifications are subject to change without prior notice by the manufacturer***